



**EQUIPAMIENTO
DE VEHÍCULOS
COMERCIALES**



**STORE
BOXSERIES**



**STORE
BOX067**

PÁG. 4



**STORE
BOX080**

PÁG. 6



**STORE
BOX102**

PÁG. 10



**STORE
BOX136**

PÁG. 12



**STORE
BOX238**

PÁG. 14



**STORE
BOX374**

PÁG. 16





STORE BOXTRAY

PÁG. 18



STORE BOXDIVIDER

PÁG. 20



STORE ROLL

PÁG. 22



STORE BOX067

ART. F 22 SB BOX067 00 01

Maletín de acero vacío A=438 P=347 H=67 mm



ART. F 22 SB BOX067 01 01

Maletín de acero con 48 compartimientos:
48 cubetas "red"



ART. F 22 SB BOX067 02 01

Maletín de acero con 24 compartimientos:
24 cubetas "yellow"



ART. F 22 SB BOX067 03 01

Maletín de acero con 12 compartimientos:
12 cubetas "blue"



ART. F 22 SB BOX067 04 01

Maletín de acero con 8 compartimientos:
8 cubetas "green"



ART. F 22 SB BOX067 05 01

Maletín de acero con 4 compartimientos:
4 cubetas "forest"



ART. F 22 SB BOX067 06 01

Maletín de acero con 23 compartimientos:
12 cubetas "red"
6 cubetas "yellow"
3 cubetas "blue"
2 cubetas "green"



ART. F 22 SB BOX067 07 01

Maletín de acero con 16 compartimientos:
 6 cubetas "red"
 5 cubetas "yellow"
 2 cubetas "blue"
 2 cubetas "green"
 1 cubeta "forest"



ART. F 22 SB BOX067 08 01

Maletín de acero con 10 compartimientos:
 3 cubetas "yellow"
 3 cubetas "blue"
 3 cubetas "green"
 1 cubeta "forest"



ART. F 22 SB BOX067 09 01

Maletín de acero con 22 compartimientos:
 12 cubetas "red"
 6 cubetas "yellow"
 3 cubetas "blue"
 1 cubeta "forest"



STORE BOX080

ART. F 22 SB BOX080 00 01

Maletín de plástico vacío A=440 P=350 H=80 mm



ART. F 22 SB BOX080 01 01

Maletín de plástico con 48 compartimentos:
48 cubetas "red"



ART. F 22 SB BOX080 02 01

Maletín de plástico con 24 compartimentos:
24 cubetas "yellow"



ART. F 22 SB BOX080 03 01

Maletín de plástico con 12 compartimentos:
12 cubetas "blue"



ART. F 22 SB BOX080 04 01

Maletín de plástico con 8 compartimentos:
8 cubetas "green"



ART. F 22 SB BOX080 05 01

Maletín de plástico con 4 compartimentos:
4 cubetas "forest"



ART. F 22 SB BOX080 06 01

Maletín de plástico con 23 compartimentos:
12 cubetas "red"
6 cubetas "yellow"
3 cubetas "blue"
2 cubetas "green"

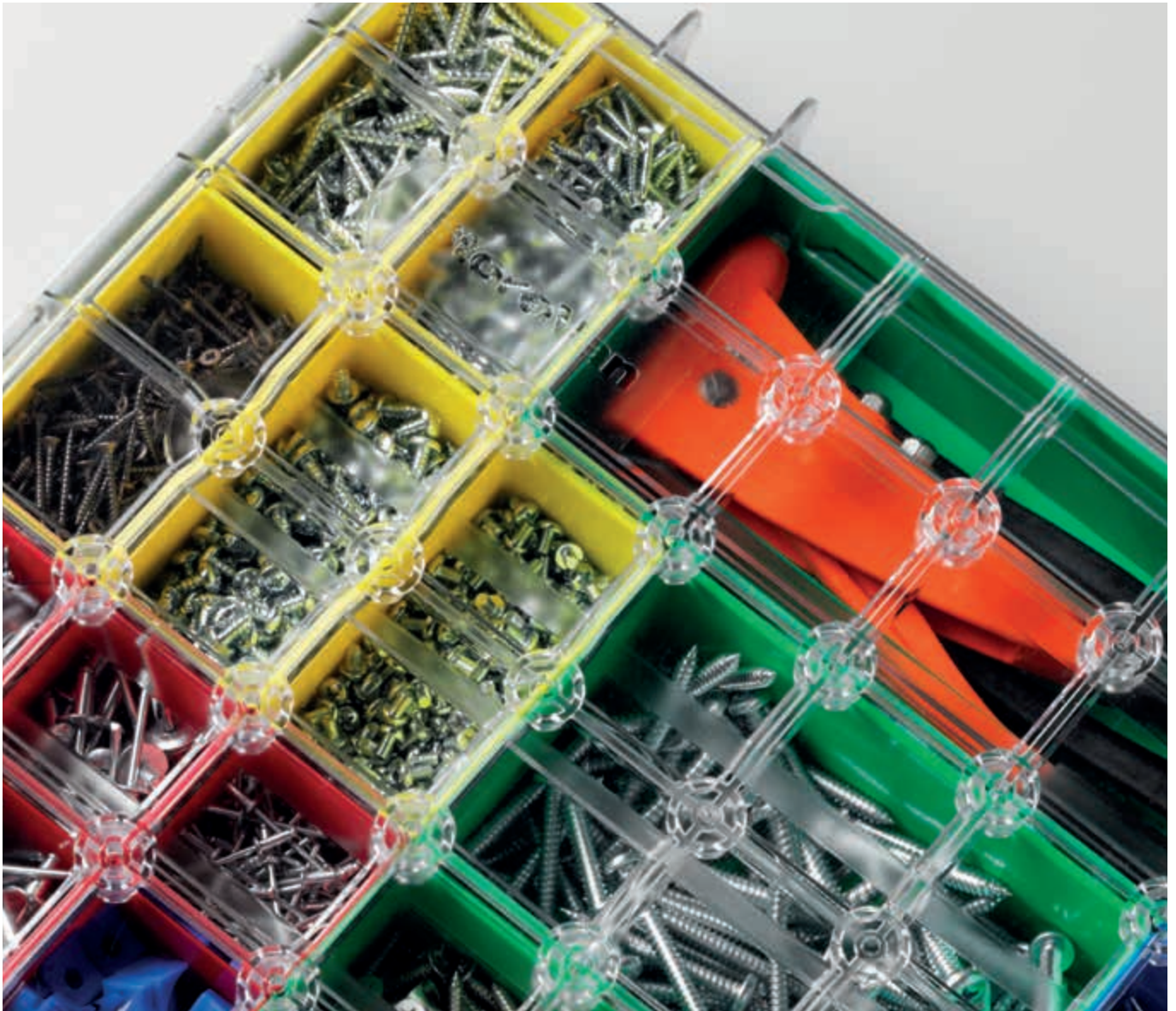

ART. F 22 SB BOX080 07 01

Maletín de plástico con 16 compartimentos:
 6 cubetas "red"
 5 cubetas "yellow"
 2 cubetas "blue"
 2 cubetas "green"
 1 cubeta "forest"



ART. F 22 SB BOX080 08 01

Maletín de plástico con 10 compartimentos:
 3 cubetas "yellow"
 3 cubetas "blue"
 3 cubetas "green"
 1 cubeta "forest"



ART. F 22 SB BOX080 09 01

Maletín de plástico con 22 compartimentos:
 12 cubetas "red"
 6 cubetas "yellow"
 3 cubetas "blue"
 1 cubeta "forest"



STORE BOX102

ART. F 22 SB BOX102 00 01

Maletín de plástico vacío A=442 P=357 H=117 mm



ART. F 22 SB BOX102 01 01

Maletín de plástico con 23 compartimentos:
1 revestimiento interior sky
2 cubetas "grey" con divisorios
6 cubetas "red"
6 cubetas "yellow"
3 cubetas "blue"



ART. F 22 SB BOX102 02 01

Maletín de plástico con 19 compartimentos:
1 revestimiento interior sky
2 cubetas "grey" con divisorios
4 cubetas "red"
3 cubetas "yellow"
2 cubetas "blue"
2 cubetas "green"



ART. F 22 SB BOX102 03 01

Maletín de plástico con 18 compartimentos:
1 revestimiento interior sky
2 cubetas "grey" con divisorios
4 cubetas "red"
3 cubetas "yellow"
2 cubetas "blue"
1 cubeta "forest"



ART. F 22 SB BOX102 04 01

Maletín de plástico con 38 compartimentos:
1 revestimiento interior sky
2 cubetas "grey" con divisorios
30 cubetas "red"



ART. F 22 SB BOX102 05 01

Maletín de plástico con 23 compartimentos:
1 revestimiento interior sky
2 cubetas "grey" con divisorios
15 cubetas "yellow"



ART. F 22 SB BOX102 06 01

Maletín de plástico con 13 compartimentos:
1 revestimiento interior sky
2 cubetas "grey" con divisorios
5 cubetas "green"



ART. F 22 SB BOX102 07 01

Maletín de plástico con 14 compartimentos:
 1 revestimiento interior sky
 2 cubetas "grey" con divisorios
 2 cubetas "red"
 2 cubetas "yellow"
 2 cubetas "forest"



ART. F 22 SB BOX102 08 01

Maletín de plástico con 17 compartimentos:
 1 revestimiento interior sky
 2 cubetas "grey" con divisorios
 3 cubetas "yellow"
 6 cubetas "blue"



ART. F 22 SB BOX102 09 01

Maletín de plástico con 14 compartimentos:
 1 revestimiento interior sky
 2 cubetas "grey" con divisorios
 3 cubetas "blue"
 3 cubetas "green"



ART. F 22 SB BOX102 10 01

Maletín de plástico con:
 1 revestimiento interior sky
 2 cubetas "grey" con divisorios
 2 store box mini63



ART. F 22 SB BOX102 11 01

Maletín de plástico con:
 1 revestimiento interior sky
 1 termoformado "dark" de 5 compartimentos



ART. F 22 SB BOX102 12 01

Maletín de plástico con:
 1 revestimiento interior sky
 1 termoformado "dark" de 12 compartimentos



STORE BOX102

ART. F 22 SB BOX102 00 01

Maletín de plástico vacío A=442 P=357 H=117 mm

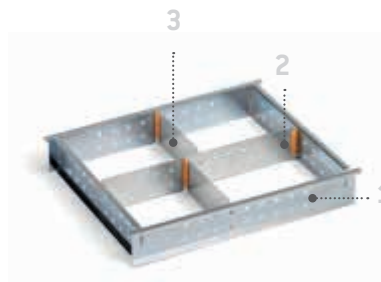

ART. F 22 SB FRA102 01 99

A=406 P=319 H=61 mm
Juego de divisorios con:
1 Bastidor FRA102
1 divisorio D35102
2 divisorios D13102

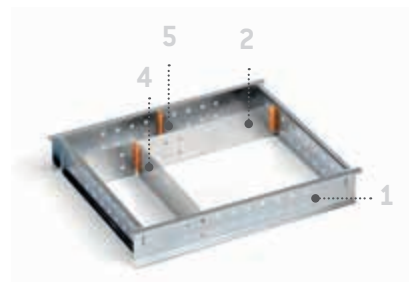

ART. F 22 SB FRA102 02 99

A=406 P=319 H=61 mm
Juego de divisorios con:
1 Bastidor FRA102
1 divisorio D35102
1 divisorio D06102
1 divisorio D21102



1

ART. F 22 SB FRA102 00 99

Bastidor de acero galvanizado para
maletín BOX102
A=406 P=319 H=61 mm



2

ART. F 22 SB D35102 00 00

Divisorio transversal de aluminio para bastidor para BOX102
A=352 P=12 H=61 mm



3

ART. F 22 SB D13102 00 00

Divisorio longitudinal de aluminio para bastidor para BOX102
A=139 H=60 mm



4

ART. F 22 SB D21102 00 00

Divisorio longitudinal de aluminio para bastidor para BOX102
A=218 H=60 mm



5

ART. F 22 SB D06102 00 00

Divisorio longitudinal de aluminio para bastidor para BOX102
A=61 H=60 mm

ART. F 22 SB MAT001 00 07

Revestimiento de goma antideslizante para
BOX102 - 136 - 238
A=362 P=300 H=1,5 mm

ART. F 22 SB SKY001 00 07

Revestimiento interior sky de espuma de polipropileno
A=400 P=320 H=20 mm





STORE BOX136

ART. F 22 SB BOX136 00 01

Maletín de plástico vacío A=442 P=357 H=151 mm

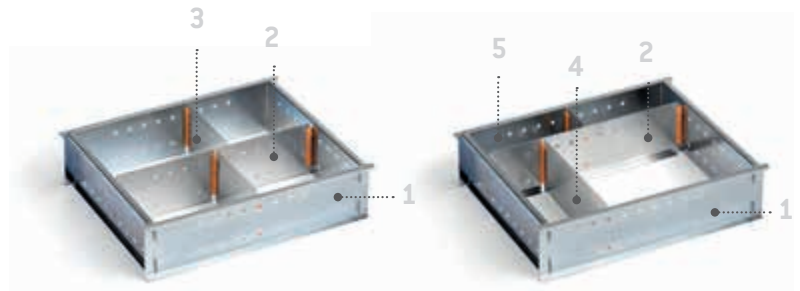

ART. F 22 SB FRA136 01 99

A=406 P=319 H=96 mm
Juego de divisorios con:
1 Bastidor FRA136
1 divisorio D35136
2 divisorios D13136

ART. F 22 SB FRA136 02 99

A=406 P=319 H=96 mm
Juego de divisorios con:
1 Bastidor FRA136
1 divisorio D35136
1 divisorio D06136
1 divisorio D21136

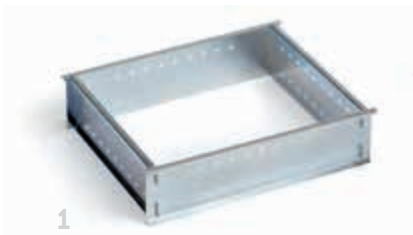

ART. F 22 SB FRA136 00 99

Bastidor de acero galvanizado para
maletín BOX136
A=406 P=319 H=96 mm



2

ART. F 22 SB D35136 00 00

Divisorio transversal de aluminio para bastidor para BOX136
A=352 P=12 H=96 mm



3

ART. F 22 SB D13136 00 00

Divisorio longitudinal de aluminio para bastidor para BOX136
A=139 H=95 mm



4

ART. F 22 SB D21136 00 00

Divisorio longitudinal de aluminio para bastidor para BOX136
A=218 H=95 mm



5

ART. F 22 SB D06136 00 00

Divisorio longitudinal de aluminio para bastidor para BOX136
A=61 H=95 mm



ART. F 22 SB MAT001 00 07

Revestimiento de goma antideslizante para
BOX102 - 136 - 238
A=362 P=300 H=1,5 mm



ART. F 22 SB SKY001 00 07

Revestimiento interior sky de espuma de polipropileno
A=400 P=320 H=20 mm



Revestimiento interior sky

Bandeja con juego de separación ver pág. 18



1

ART. F 22 SB SUP136 00 99

Soporte de acero galvanizado para maletín BOX136
A=401 P=311 H=32 mm





STORE BOX238

ART. F 22 SB BOX238 00 01

Maletín de plástico vacío A=442 P=357 H=253 mm



ART. F 22 SB FRA238 03 99

A=402 P=312 H=194 mm

Juego de divisorios con:

1 Bastidor FRA238

1 divisorio D36238

2 divisorios D14238

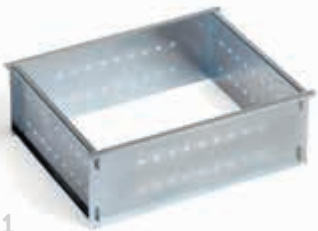

ART. F 22 SB FRA238 00 99

Bastidor de acero galvanizado para
maletín BOX238 - BOX374
A=402 P=312 H=132 mm



2

ART. F 22 SB D36238 00 00

Divisorio transversal de aluminio
para bastidor para BOX238
A=352 P=12 H=194 mm



3

ART. F 22 SB D14238 00 00

Divisorio longitudinal de aluminio
para bastidor para BOX238
A=135 H=193 mm

ART. F 22 SB MAT001 00 07

Revestimiento de goma antideslizante para
BOX102 - 136 - 238
A=362 P=300 H=1,5 mm



ART. F 22 SB SKY001 00 07

Revestimiento interior sky de espuma de polipropileno
A=400 P=320 H=20 mm

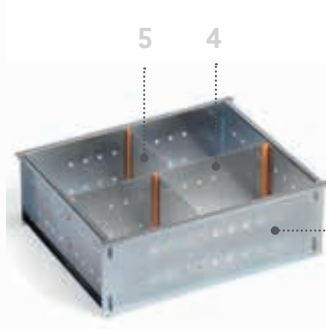

Revestimiento interior sky

Bandeja con juego de separación ver
pág. 18

ART. F 22 SB FRA238 01 99

A=402 P=312 H=132 mm
Juego de divisores con:
1 Bastidor FRA238
1 divisorio D35238
2 divisores D13238

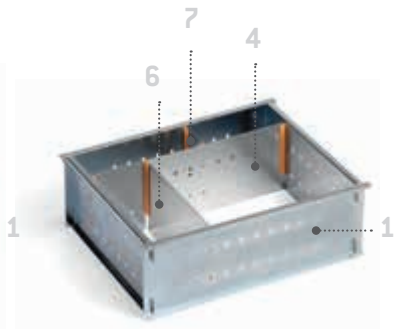
ART. F 22 SB FRA238 02 99

A=402 P=312 H=132 mm
Juego de divisores con:
1 Bastidor FRA238
1 divisorio D35238
1 divisorio D05238
1 divisorio D21238

ART. F 22 SB FRA238 00 99

Bastidor de acero galvanizado para
maletín BOX238 - BOX374
A=402 P=312 H=132 mm

ART. F 22 SB D35238 00 00

Divisorio transversal de aluminio para bastidor para BOX238
A=352 P=12 H=132 mm

ART. F 22 SB D13238 00 00

Divisorio longitudinal de aluminio para bastidor para BOX238
A=135 H=131 mm



6

ART. F 22 SB D21238 00 00

Divisorio longitudinal de aluminio para bastidor para BOX238
A=213 H=131 mm



7

ART. F 22 SB D05238 00 00

Divisorio longitudinal de aluminio para bastidor para BOX238
A=57 H=131 mm



STORE BOX374

ART. F 22 SB BOX374 00 01

Maletín de plástico vacío A=442 P=357 H=389 mm

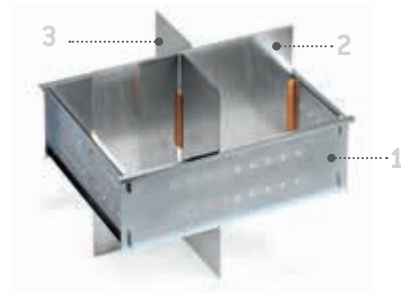

ART. F 22 SB FRA374 01 99

A=402 P=312 H=330 mm

Juego de divisorios con:

1 Bastidor FRA238

1 divisorio D36374

2 divisorios D14374

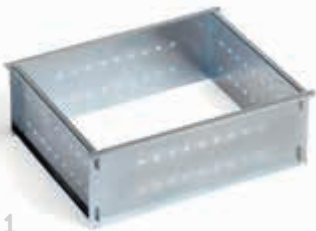

1

ART. F 22 SB FRA238 00 99

Bastidor de acero galvanizado para
maletín BOX238 - BOX374
A=402 P=312 H=132 mm



2

ART. F 22 SB D36374 00 00

Divisorio transversal de aluminio para bastidor para BOX374
A=352 P=12 H=330 mm



3

ART. F 22 SB D14374 00 00

Divisorio longitudinal de aluminio para bastidor para BOX374
A=135 H=329 mm



ART. F 22 SB MAT002 00 07

Revestimiento de goma antideslizante para BOX374
A=362 P=290 H=1,5 mm



ART. F 22 SB SKY001 00 07

Revestimiento interior sky de espuma de polipropileno
A=400 P=320 H=20 mm



Revestimiento interior sky

Bandeja con juego de separación ver pág. 18

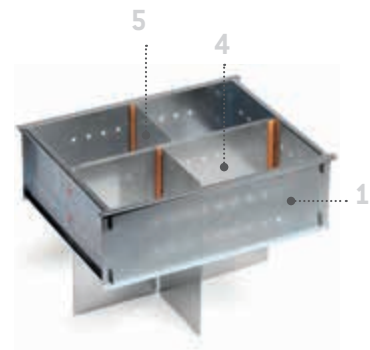

ART. F 22 SB FRA374 02 99

A=402 P=312 H=260 mm
Juego de divisorios con:
1 Bastidor FRA238
1 divisorio D35374
2 divisorios D13374

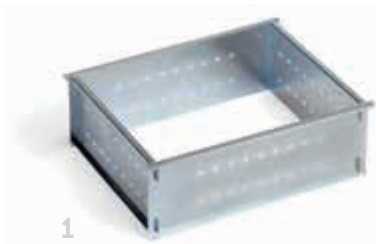

ART. F 22 SB FRA238 00 99

Bastidor de acero galvanizado para maletín BOX238 - BOX374
A=402 P=312 H=132 mm



4

ART. F 22 SB D35374 00 00

Divisorio transversal de aluminio para bastidor para BOX374
A=352 P=12 H=260 mm



5

ART. F 22 SB D13374 00 00

Divisorio longitudinal de aluminio para bastidor para BOX374
A=135 H=259 mm

STORE BOXTRAY



ART. F 22 SB 00TRAY 00 01

Bandeja de acero vacía para Store Box 136 - 238 - 374
A=380 P=313 H=65 mm



ART. F 22 SB 00TRAY 01 01

Bandeja de acero con 23 compartimientos:
2 cubetas "grey" con divisorios
6 cubetas "red"
6 cubetas "yellow"
3 cubetas "blue"



ART. F 22 SB 00TRAY 02 01

Bandeja de acero con 19 compartimientos:
2 cubetas "grey" con divisorios
4 cubetas "red"
3 cubetas "yellow"
2 cubetas "blue"
2 cubetas "green"



ART. F 22 SB 00TRAY 03 01

Bandeja de acero con 18 compartimientos:
2 cubetas "grey" con divisorios
4 cubetas "red"
3 cubetas "yellow"
2 cubetas "blue"
1 cubeta "forest"



ART. F 22 SB 00TRAY 04 01

Bandeja de acero con 38 compartimientos:
2 cubetas "grey" con divisorios
30 cubetas "red"



ART. F 22 SB 00TRAY 05 01

Bandeja de acero con 23 compartimientos:
2 cubetas "grey" con divisorios
15 cubetas "yellow"



ART. F 22 SB 00TRAY 06 01

Bandeja de acero con 13 compartimientos:
2 cubetas "grey" con divisorios
5 cubetas "green"



ART. F 22 SB 00TRAY 07 01

Bandeja de acero con 14 compartimientos:
2 cubetas "grey" con divisorios
2 cubetas "red"
2 cubetas "yellow"
2 cubetas "forest"



ART. F 22 SB 00TRAY 08 01

Bandeja de acero con 17 compartimientos:
2 cubetas "grey" con divisorios
3 cubetas "yellow"
6 cubetas "blue"



ART. F 22 SB 00TRAY 09 01

Bandeja de acero con 14 compartimientos:
2 cubetas "grey" con divisorios
3 cubetas "blue"
3 cubetas "green"



ART. F 22 SB 00TRAY 10 01

Bandeja de acero con:
2 cubetas "grey" con divisorios
2 store box mini63



ART. F 22 SB 00TRAY 11 01

Bandeja de acero con:
1 termoformado "dark" de 5 compartimientos



ART. F 22 SB 00TRAY 12 01

Bandeja de acero con:
1 termoformado "dark" de 12 compartimientos

STORE BOXDIVIDER



ART. F 22 SB 000RED 63 03

Cubeta "red" A=52 P=52 H=63

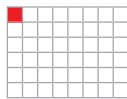

BOX067
BOX080

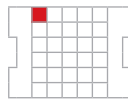

BOX102
BOXTRAY

ART. F 22 SB YELLOW 63 05

Cubeta "yellow" A=52 P=104 H=63

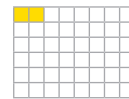

BOX067
BOX080



BOX102
BOXTRAY

ART. F 22 SB 00BLUE 63 16

Cubeta "blue" A=104 P=104 H=63

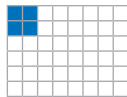

BOX067
BOX080

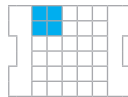

BOX102
BOXTRAY

ART. F 22 SB 06GREEN 63 14

Cubeta "green" A=104 P=156 H=63

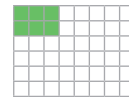

BOX067
BOX080

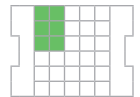

BOX102
BOXTRAY

ART. F 22 SB FOREST 63 09

Cubeta "forest" A=104 P=312 H=63

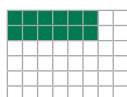

BOX067
BOX080

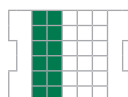

BOX102
BOXTRAY

ART. F 22 SB MINI63 63 08

Store Box Mini63 A=260 P=155 H=63

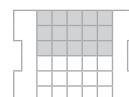

BOX102
BOXTRAY



ART. F 22 SB 00GREY 63 01

Cubeta "grey" A=71 P=312 H=63



BOX102
BOXTRAY

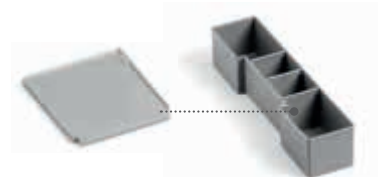

ART. F 22 SB DVGREY 58 01

Divisorio para cubeta "grey" A=52 P=4 H=58



ART. F 22 SB DARK05 62 07

Termoformado "dark" de 5 compartimentos
A=405 P=315 H=62



BOX102
BOXTRAY



ART. F 22 SB DARK12 62 07

Termoformado "dark" de 12 compartimentos
A=405 P=315 H=62



BOX102
BOXTRAY



STORE ROLL

ART. F 22 SB 00ROLL 00 08

Carro para maletín BOX102 - 136 - 238 - 374
con cuatro ruedas giratorias, dos de ellas con freno
Capacidad de carga 100 kg
A=650 P=510 H=150 mm





WWW.STOREVAN.COM



FAMI S.r.l.

Via Stazione Rossano, 13 | 36027 Rosà (VI) | ITALY
phone +39 0424 585455 | fax +39 0424 585482
www.famispaspa.com | info@famispaspa.com
www.storevan.com | info@storevan.com